

USER MANUAL  
SCR22 / SCR35 / SCR22PL / SCR35PL  
**Digital label finishing system**

WITH GRAPHTEC CE8000-40

THIS PRODUCT IS CERTIFIED:







**IMPORTANT:** Please keep the original packaging in case you need to return the material. If we receive the system in non-original packaging, the warranty will be void.



**IMPORTANT:** The latest version of the Scorpio Series software is available on our websites **[www.dpr-srl.it](http://www.dpr-srl.it)** or **[www.dpr-llc.com](http://www.dpr-llc.com)**, section "Download".



# INDEX

System requirements .....	page 6
How to install outer discs .....	page 6
How to install the plotter .....	page 6
How to install the cutting plotter.....	page 7
Software activation.....	page 9
How to install the core holder.....	page 9
How to load and operate with the lamination module.....	page 10
How to set the lamination sensor.....	page 11
Load the media into the plotter.....	page 12
How to run the cut test and start a job.....	page 13
How load the matrix remover & slitter .....	page 15
How to load the matrix remover core holder .....	page 16
How to load the rewinder core holder and set the slitter module .....	page 16
How to add or remove blade holder .....	page 18
Metal guide alignment .....	page 18
Error Messages .....	page 19
Black-mark detection .....	page 19
Cutting file specifications .....	page 20
Black-mark position into the cutting file and printed artwork.....	page 20
Black-mark position in the media .....	page 21
How to cut blank labels .....	page 21
How to update software .....	page 22
How to restore plotter settings .....	page 22
How and when to reduce the plotter feeding speed .....	page 24
Media path .....	page 25
Ultrasonic sensor calibration.....	page 25
Lamination / matrix remover&slitter modules speed rotation .....	page 26
How to install pressing roller .....	page 27
How to used the o-ring on the matrix roller .....	page 27
Narrower media on the SCR35 and SCR35PL.....	page 27
Graphtec maintenance .....	page 28
How to replace the knife .....	page 30
How to replace the slitter blade .....	page 30
How to replace the cutting mat .....	page 31
How to create the QR Code.....	page 32
Troubleshooting .....	page 34

## SYSTEM REQUIREMENTS

---

The cutting manager works on Windows OS from Windows 8.1. We do not guarantee its functionality on previous versions. Not compatible with macOS systems.

Cutting files: Adobe Illustrator, CorelDraw or Inkscape (PDF).

Diagram connectors behind the on-off panel.

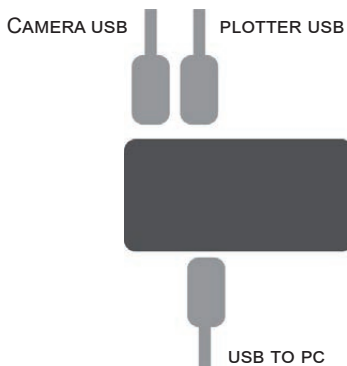

## HOW TO INSTALL OUTER DISC

---

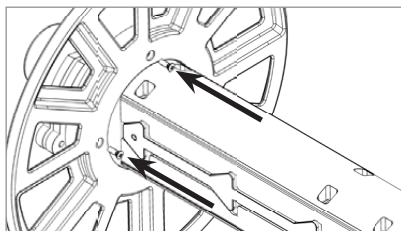

Using a screwdriver, install the outer disc on the Core Holder for printed rolls.

## HOW TO INSTALL THE PLOTTER

---

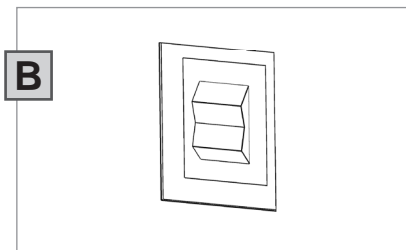
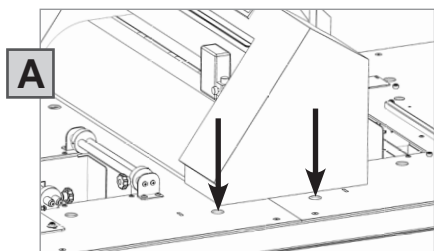

A. Pull the plotter from the packaging and place it on the plate, make sure to push the rubber feet into the holes.

B. Plug the machine and switch on.

# HOW TO INSTALL THE CUTTING PLOTTER

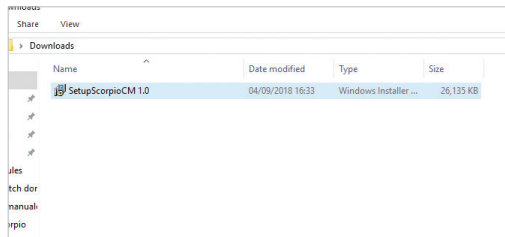

1. Click on “SetupScorpioCM...” and follow the step by step instructions to complete the installation.

Please DO NOT connect the scorpio USB to your pc before the installation is complete

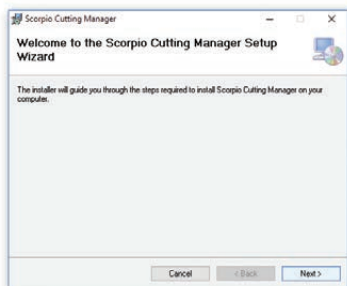

2. Click NEXT

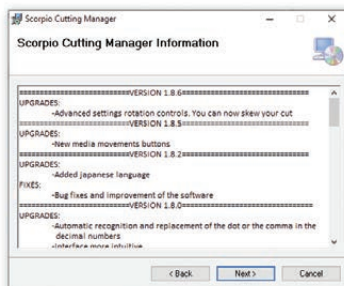

3. Click NEXT

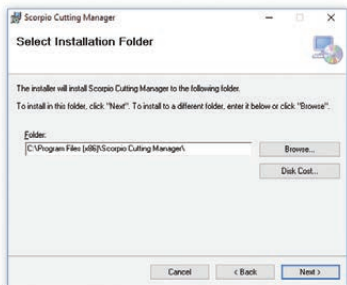

4. Click NEXT

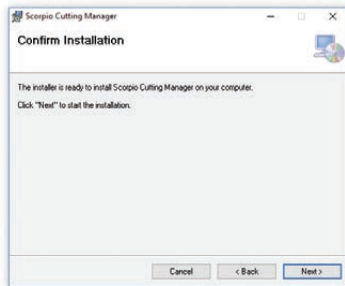

5. Click YES

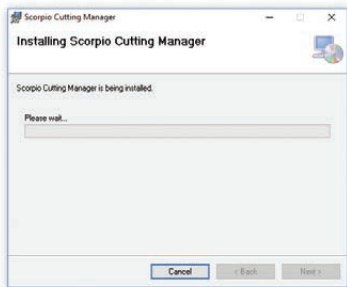

6. In process

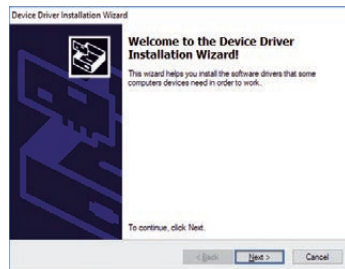

7. Click NEXT

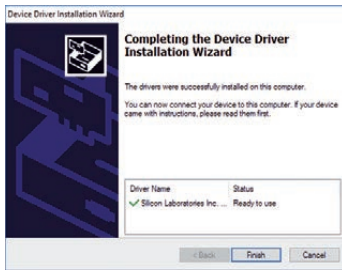

8. Click FINISH

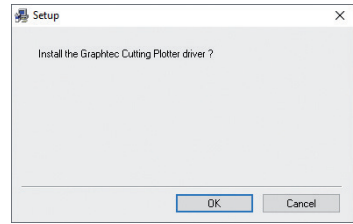

9. Click OK

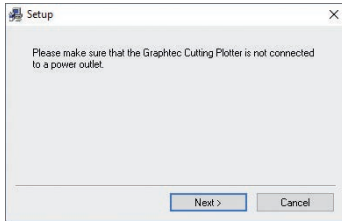

10. Click NEXT (Remove the scorpio USB from your pc, and turn off the scorpio)

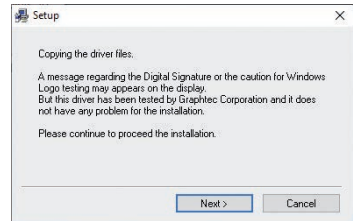

11. Click NEXT

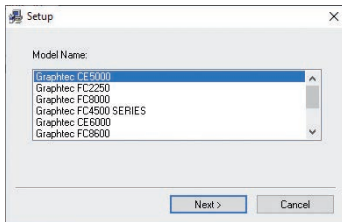

12. Choose the right model name of your Graphtec (CE8000-40).

Click NEXT



13. Wait until the sign "Update for the Graphtec CE8000-40 driver was completed" shows up. You may need to restart the computer.

Click OK

*The installation is completed. A ScorpioCM shortcut is displayed on your desktop*



Plug in the USB camera and the USB dongle, they will auto-install.

**If your computer already has a camera installed, we recommend disabling it. If you do not, your pc will ignore the camera on the plotter.**

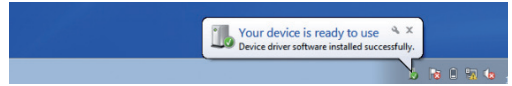
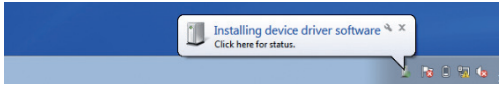

CM Software will generate a folder in the Windows start menu.

## SOFTWARE ACTIVATION

---



To activate the software you must have **one of these options**:

- The unit's key, which can be found attached to the plotter. *(valid up to 3 activations)*  
**WHEN YOU ACTIVATE THE LICENSE YOU MUST BE CONNECTED TO INTERNET**

or

- A red dongle (already plugged inside the unit).

## HOW TO INSTALL THE CORE HOLDER

---

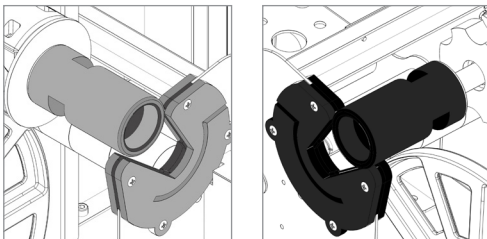

The grey handle must match with the grey holder and the black handle with the black holder.

**IMPORTANT:** screws must be face down.

# HOW TO LOAD AND OPERATE THE LAMINATION MODULE

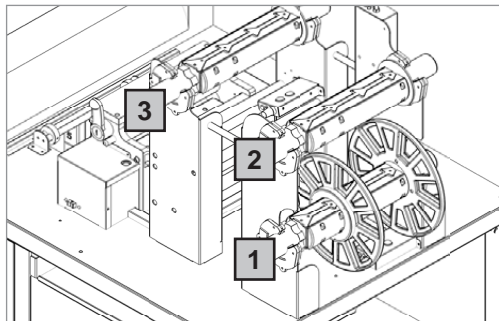

Core Holder No. 1 > Printed roll

Core Holder No. 2 > Liner roll

Core Holder No. 3 > Laminate roll

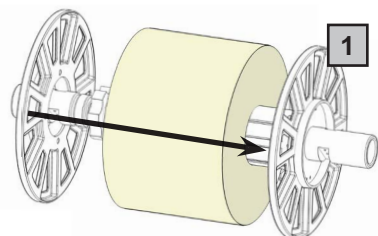

Load the printed roll and move it against the roll guide. Tighten the core holder.

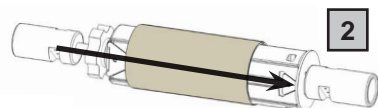

Load an empty cardboard core onto the shaft intended for laminate liner rewinding. Tighten the core holder.

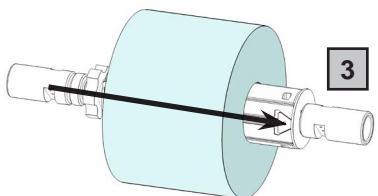

Load the lamination roll, move it along the supply shaft and make sure the lamination is aligned with the media roll.

**IMPORTANT:** the lamination roll always needs to be narrower than the web width.

*Example: if the web width is 7" then the lamination roll needs to be lesser than 7" (let's say 1/4 inch on each end).*

At this point you can tighten the core holder.

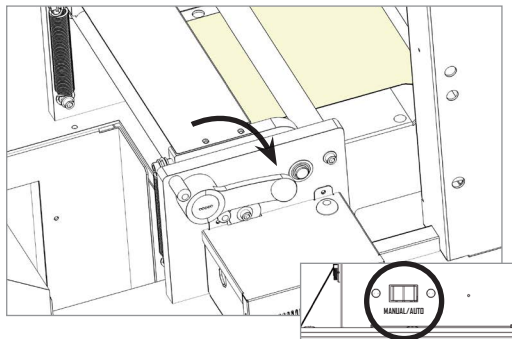

When the LEDs on the control board are off, the device works on a manual feeding.

Move the media through the rollers, close the nip roller and press the FORWARD button. The media will be loaded through the rollers.

Switch on "**Auto**" button to active the automatic media feeding mood. The green led will be on.

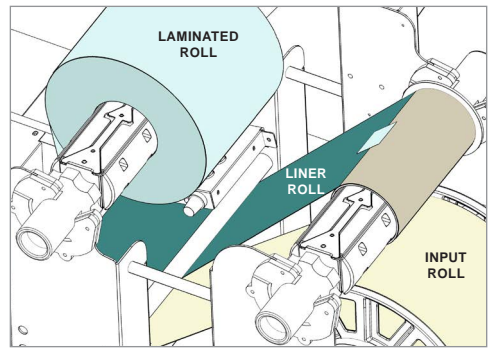
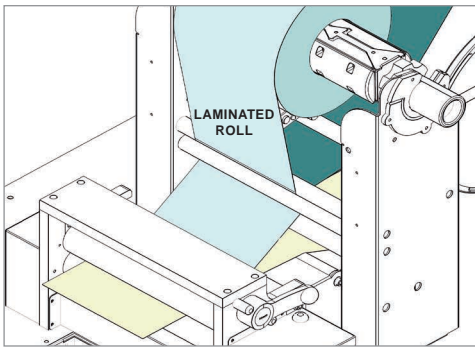

Hold the laminating film with both hands, pull it through the guide rollers, center it and adhere the laminating film to the web and attach the liner onto cardboard.

!PLEASE LOOK AT THE LAMINATION PATH! (PAGE 25)

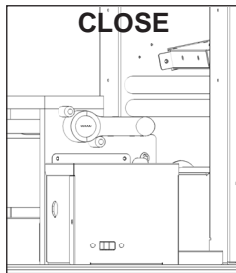
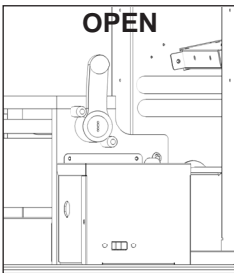

Using the black knob to open or close the nip roller.

This will apply pressure on the laminating film to adhere to the media avoiding any possible air bubbles.

When both yellow and green leds are flashing it means the system is in error status. The error occurs when the media roll, lamination roll or both are not loaded, broken or simply they are run out.

To clear the error it is just necessary to restart the module switching "Manual" then "Auto" button again.

### MEDIA TENSION CONTROL

Each core holder (ON THE LAMINATING & UNWINDING MODULE) is managed by its own controller designed to set the required media tension, keeping that tension automatically constant even the roll diameter variation during the job.

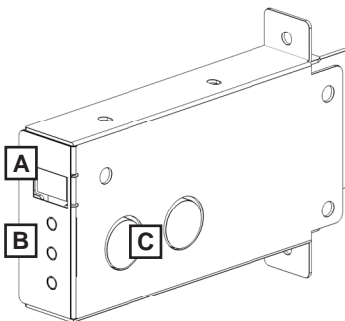

A) Display

B) ON/OFF : activate/deactivate the tension control

+ : increase the media tension

- : decrease the media tension

C) Ultrasonic sensor

Display conditions:

- flashing O - F - F = the controller is deactivated

- flashing number = the controller is active and it shows the tension level set

Keeping "run" pressed; the core will spin

## LOAD THE MEDIA INTO THE PLOTTER

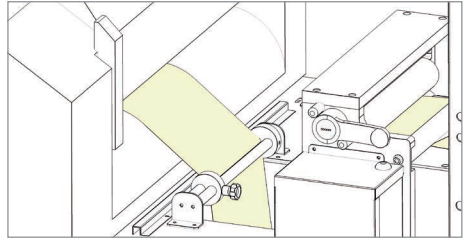
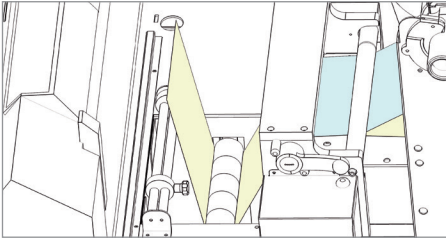

Pull the laminated media underneath the tension arm, than pass it through the aluminium rollers, the guide can be adjusted preventing the web from rolling.

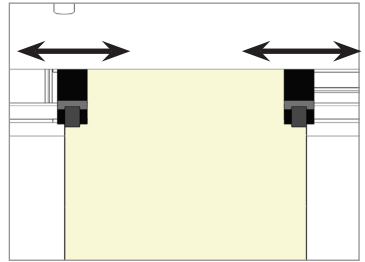
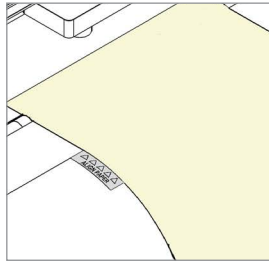
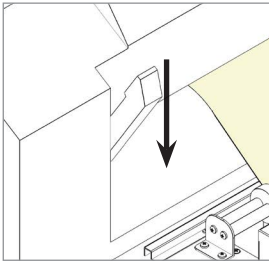

Put the lever, located in the rear of the plotter, in the down position.  
Pull the media through the plotter and keep the media edge aligned to the alignment points.

**Set both pinch rollers at the media edge.**

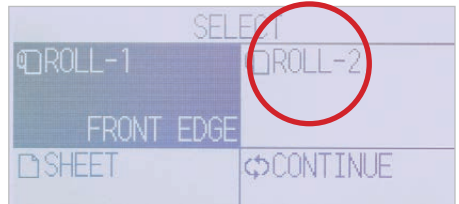
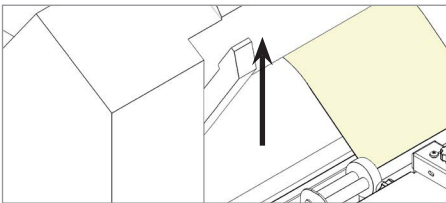

While holding down the media in the aligned position, lift the lever back to its up position. This will lock the media in place.

Press "ROLL-2" as requested on plotter's display.

## >> How to run the black-mark mode

1. Open Scorpio Cutting Manager.
2. Press “*OPEN PDF*” or “*OPEN LAST JOB*” to load the cutting file.
3. Look at the camera preview, hold down “*BACKWARD MEDIA*” or “*FORWARD MEDIA*” arrows to move the web until the black-mark goes in the center position of the blue rectangle area.

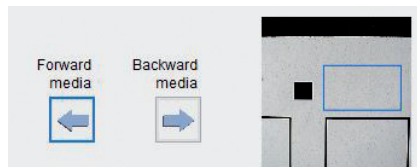

NO



YES

4. Measure the distance in (MM) between the top of one black-mark to top of the next black-mark, key in this value in the “*DISTANCE BETWEEN BLACKMARKS*” box section.



### **IMPORTANT:**

Working with *SCR22* or *SCR35* models, please open “**ADVANCED BUTTON**”, click on Settings and uncheck Media/Lamination Sensor option, then save and close the pop up.

5. Make sure the “*Enable*” in the blank mode is unflagged.
6. Press “*CUT TEST*” to check for cut depth. If the liner has been cut, decrease the cutter pressure value in the cut force box. If label doesn’t detach, increase the cutter pressure value in the cut force box.
7. Make sure label is aligned with the cut. **Through X and Y values, adjust offsets if cut doesn’t match label.**

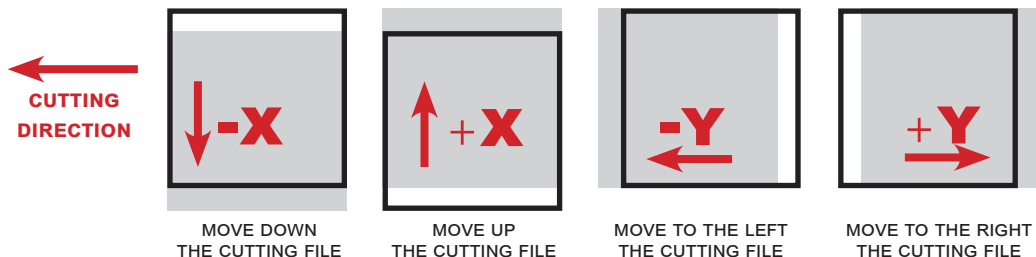

8. Once the cut settings are properly set, select “*COPY MODE*” **ON** if you desire a preset quantity of copies or **OFF** if you desire unlimited copies until the media roll is finished.
9. Set the black-mark size” in “*BLACK-MARK MODE*” area.
10. Press “*START*”.



**IMPORTANT:**

Whenever you lower and rise the lever while you are in black-mark mode, hold down the forward media arrow button to move again the plotter’s head down.

## >> ***How to run the blank mode***

1. Press “OPEN PDF” or “OPEN LAST JOB” to load the cut file.
2. Set the copy mode **ON**, and set 2 as number of copies.
3. Click “START”.
4. Check the horizontal position and the gap between the cuts.
5. If necessary, adjust the offset X and the distance between each cut in the “STEP” box.
6. Once the cut is set properly, select copy mode: ON if you desire a preset quantity of copies, or OFF to cut until the media roll is empty.
7. Working with *SCR22* or *SCR35* models, please open Advanced button, click on Settings and uncheck Media/Lamination Sensor option, then save and close the pop up.
8. Click “START”.



**IMPORTANT:**

Working with *SCR22* or *SCR35* models, please open “**ADVANCED BUTTON**”, click on Settings and uncheck Media/Lamination Sensor option, then save and close the pop up.

## HOW LOAD THE MATRIX REMOVER & SLITTER

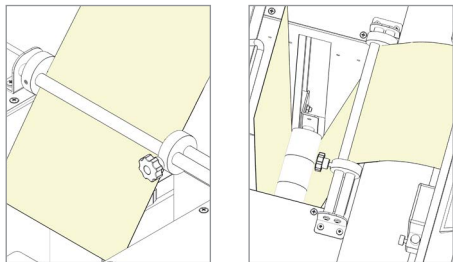

After you CUT TEST is successful, press "START" to cut a few labels until you think you have enough media to load onto the matrix remover.

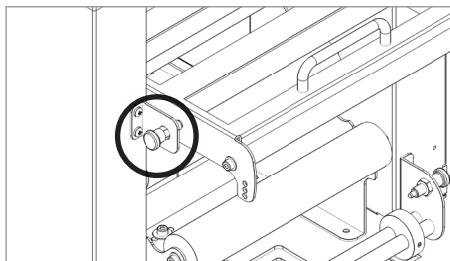
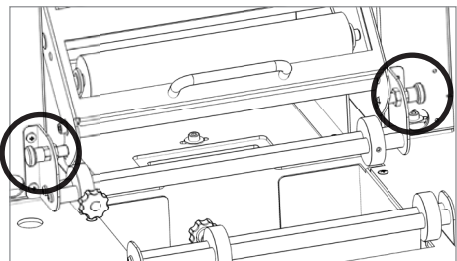

Pull the sides of the black knobs and lift up the clutch system, other black knobs will keep it open.

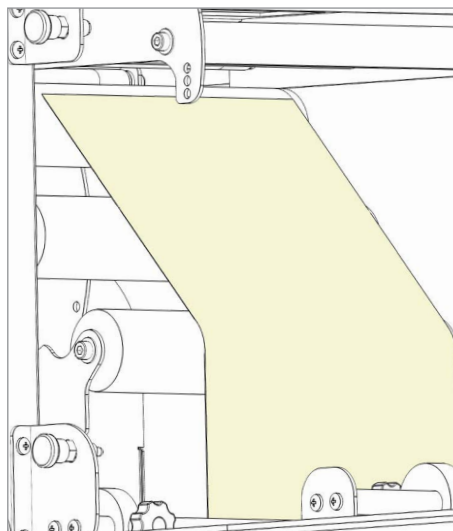

Pull the media through the aluminium rollers first (the guide can be adjusted in order to prevent the web from rolling) then through the clutch system. Close the loading system and the media will be automatically loaded into the clutch path.

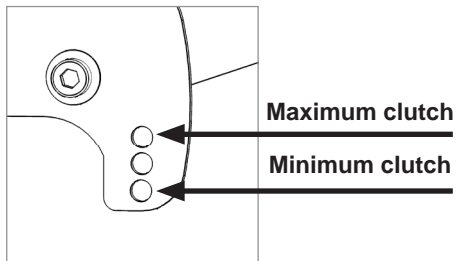

The user can adjust the clutch force thanks to the position of the clutch system.

Maximum Clutch (rewinded roll more tight)

Minimum Clutch (rewinded roll less tight)

## HOW TO LOAD THE MATRIX REMOVER CORE HOLDER



**WARNING:** Before starting a job, always remove the waste media from the matrix remover core.

Tape the matrix securely onto the cardboard core.

**System operating issues may occur if the above suggestions are not followed.**

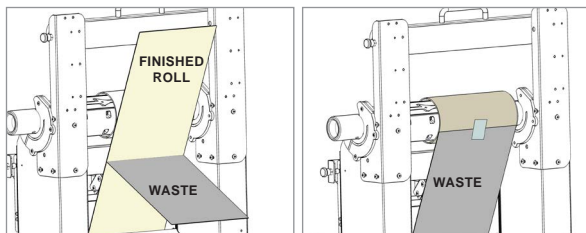
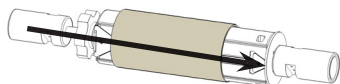

1. Load empty cardboard core(s) and tighten the core holder, then place the motorized core holder in position.
2. Peel back the matrix.
3. Pull the matrix and attach it to the matrix remover core holder.

## HOW TO LOAD THE REWINDER CORE HOLDER AND SET THE SLITTER MODULE

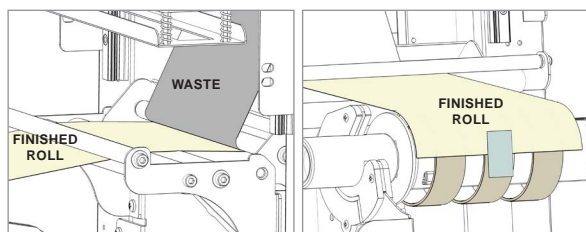
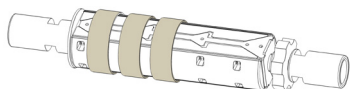

1. Load empty cardboard core(s) and tighten the core holder, then place the motorized core holder in position.

***(Cardboard core(s) width should equal (or narrower) the width of the finished roll).***

2. Pull the media through the aluminium rollers and attach the labels to the core using a waste label.

!PLEASE LOOK AT THE LAMINATION PATH! (PAGE 25)



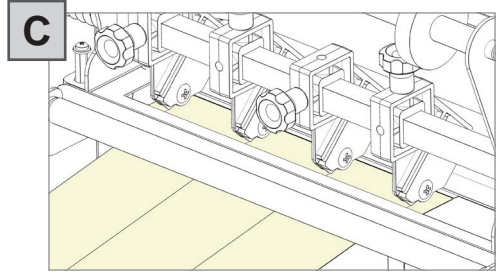
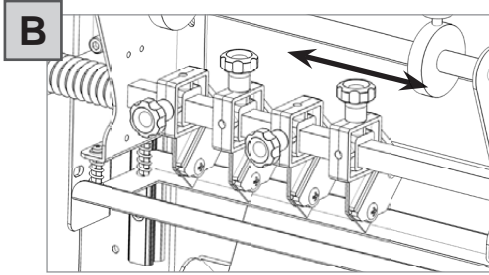
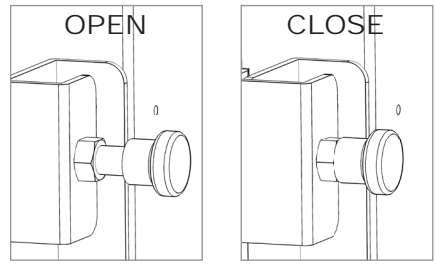
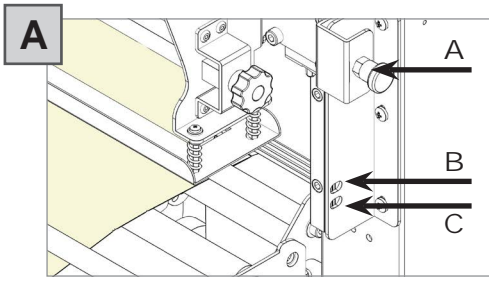

**Slitter module has 3 positions:**

- Upper position (A), the blades are lifted to allow the media loading;
- Middle position (B), align the blades with the edges and the center of the labels, tighten the thumb screw once the blade is in position;
- Lower position (C), the blade cut the media.

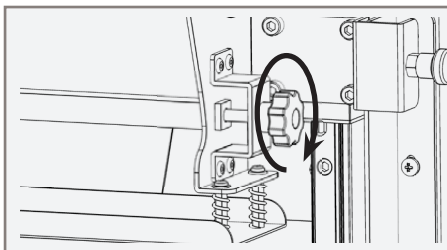

The black knobs lock the slitter module in the requested position. Screw the thumb knobs to move the blades to the right or to the left.

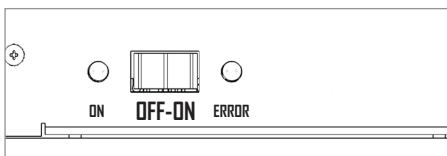

3. Turn ON the Matrix Remover module to rewind and start to split the media, than turn OFF.

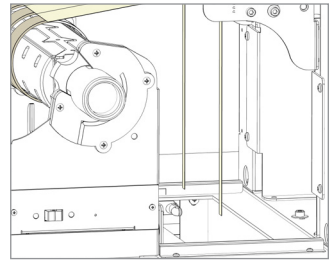
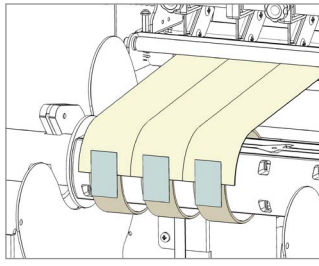
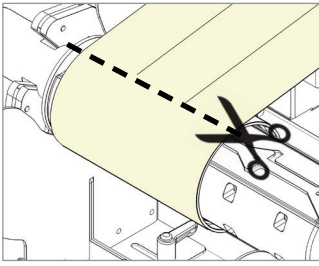

4. Cut the labels when the first “good” labels are visible;
5. Make sure the tension on all rolls is even and attach each label to the core using a waste label;
6. Feed edges trim waste into the waste basket under the hole.

**Press RESUME to start your finishing process.**

## HOW TO ADD OR REMOVE A BLADE HOLDER

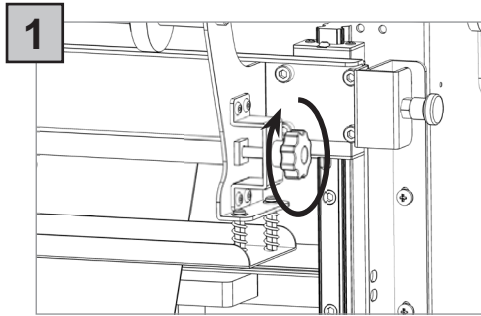

1 Remove the iron bar by unscrewing the black thumb screw.

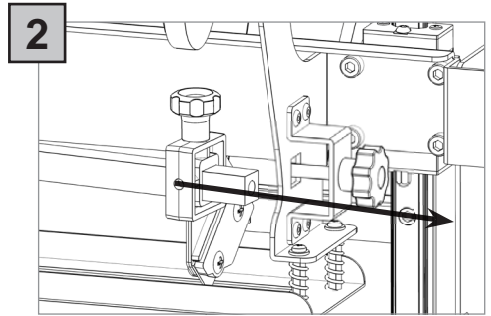

2 Slide in or out the blade holder. Relocate the slide iron bar in its position and rescrew the thumb screw.

## METAL GUIDE ALIGNMENT

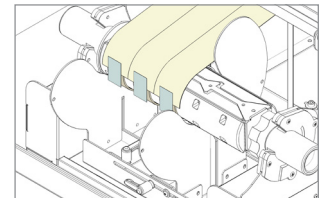
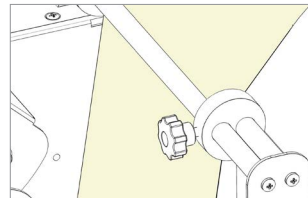
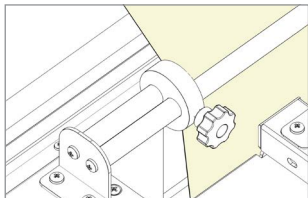

Metal guides can be adjusted in order to prevent the web from rolling.

## ERROR MESSAGES

---

If the plotter is not connected correctly to the computer, the following errors will be displayed at the application launch:

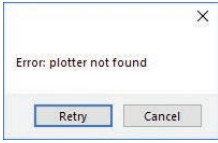

Make sure the plotter is switched on and properly connected. In case it is turned off, please turn the plotter on and then press the button 2 on control panel and wait until the display will show "READY" as status. Then press retry on the popup window.

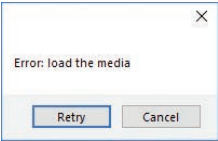

Ensure the media is loaded properly. Raise the lever on the plotter, then press the number 2 on control panel. wait until the display will show "READY" as the status. Then press retry on the popup window.

## BLACK-MARK DETECTION

---

To prevent any issues, it is important that the camera is reading the black-mark properly.

Look at the camera preview, hold down "BACKWARD MEDIA" or "FORWARD MEDIA" arrows to move the web until the black-mark goes in the center position of the blue rectangle area.

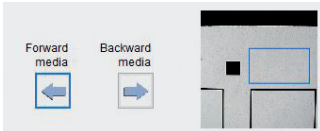

WRONG POSITION

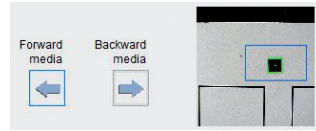

CORRECT POSITION

# CUTTING FILE SPECIFICATIONS

## Cut Files: Adobe Illustrator and/or Corel Draw (save as PDF file).

The artwork file within the cutting shape must include a registration square black mark having a size of 4x4mm or 2x2mm.

Only the cut contour lines (which must be completely vectorial and don't contain any filling) and black mark (not needed for the blank labels) can be in the saved cut file.

Graphics layers must be deleted or the cut line shapes must be copied in a new file and saved instead of hiding or disabling any extra content.



The cutting shape must be 100% black (otherwise in case of dashed lines, it must be a 100% magenta normal line) and have a thickness of 1 pt.

**The black-mark MUST ALWAYS be the object placed in the lower left corner of any layout file.**

*The Scorpio Cutting Manager (SCORPIO CM) work with the VECTOR PDF FILE. You can create this file with Adobe Illustrator or Corel Draw.*

### **MOST IMPORTANT:**

To guarantee the black marks size and its position printed correctly on the media, the artwork must be printed with the actual size, make sure to avoid any fit or scale

## BLACK-MARK POSITION INTO THE CUTTING FILE AND PRINTED ARTWORK

Black-mark size: 4x4mm or 2x2mm

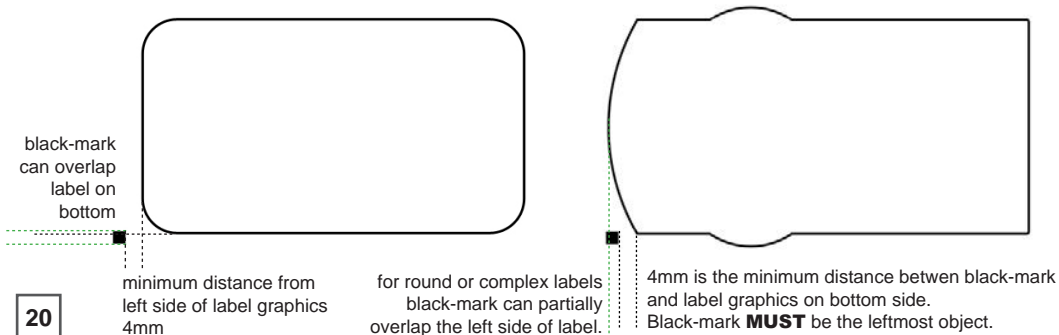

# BLACK-MARK POSITION IN THE MEDIA

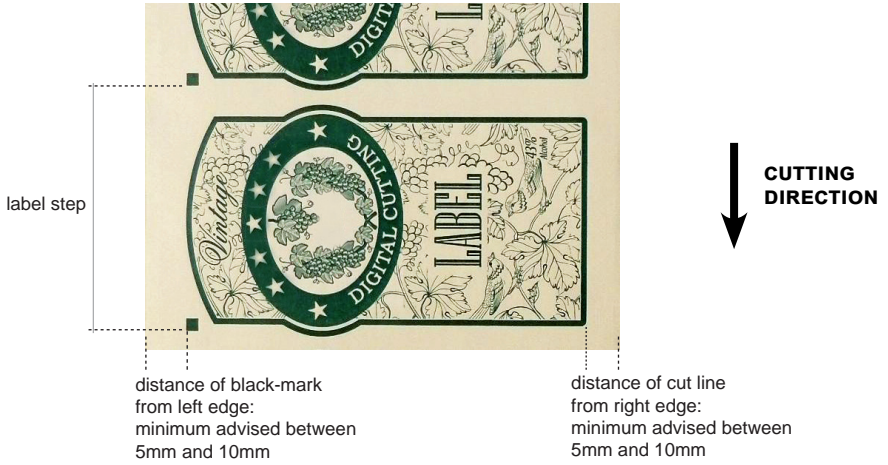

## HOW TO CUT BLANK LABELS

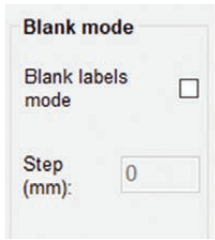

If you wish to use the “blank label” feature to cut blank labels (without registration mark), please follow these steps:

1. Import the cut file (without registration mark) into the software.
2. Select the “blank label” feature from the software and enter the number of copies that you wish to cut.
3. Click “Start”.

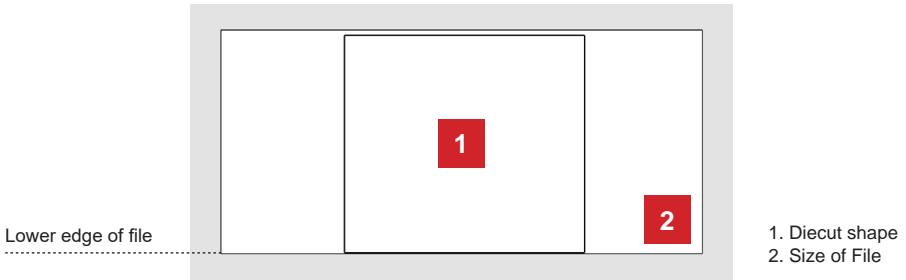

The diecut shape must be attached to the bottom edge of the file. The distance you leave will automatically be added to the gap that you will enter in the “STEP” item.



**WARNING:** Please note that enabling the blank label feature will disable both cut test and Y offset adjustment.

## HOW TO UPDATE SOFTWARE

---

1. Go to Panel control.
2. Uninstall Scorpio Cutting Manager.
3. Download from the website the new Cutting Manager release and run the installation.

## HOW TO RESTORE PLOTTER SETTINGS

---

1. Turn off the plotter.
2. Turn on the plotter while keeping pushed the UP arrow on the panel.

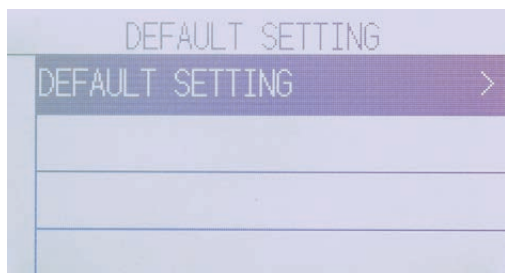

3. When the display shows "DEFAULT SETTING" press ENTER.

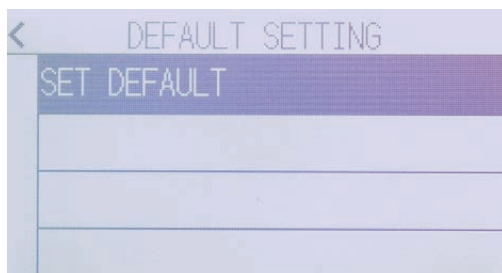

4. Press "SET SETTING"

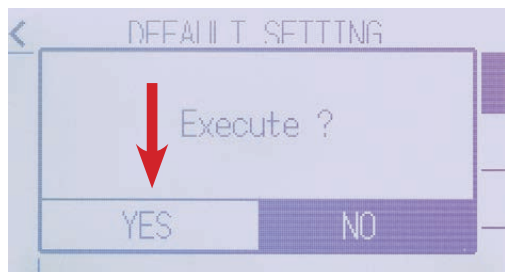

5. Press "YES".



6. In process.



7. When the display shows "SET DEFAULT COMPLETE" switch off the plotter

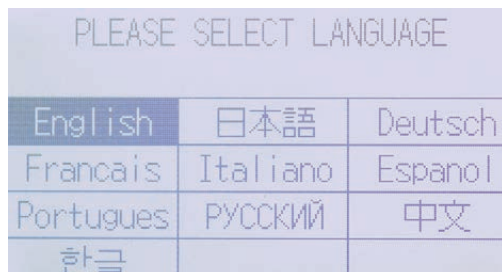

8. Turn on the plotter, choose "English" and press enter.

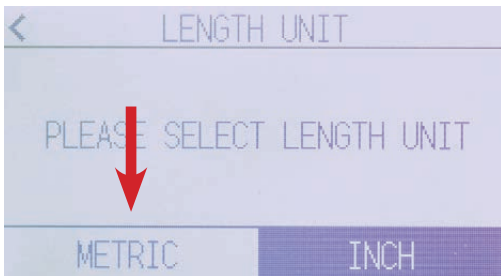

9. Press **metric**. If request, do not set up the wireless lan

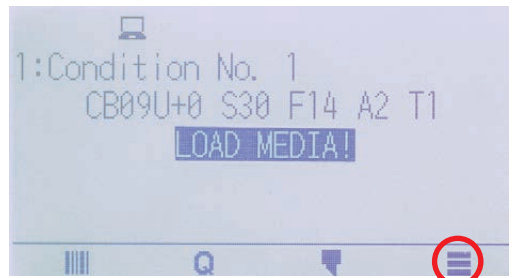

10. Lower the lever on the back and press on the three lines at the bottom right

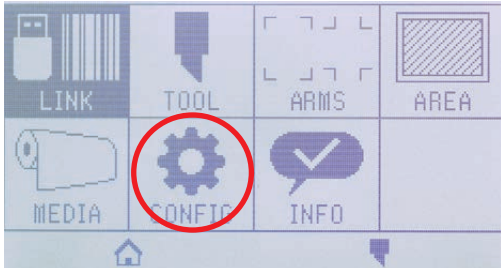

11. Press "CONFIG"



12. Select "COMMAND"

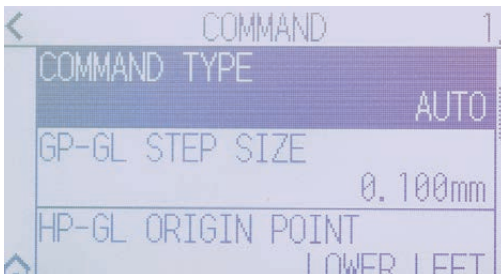

13. Select "COMMAND TYPE"



14. Select GPGL.

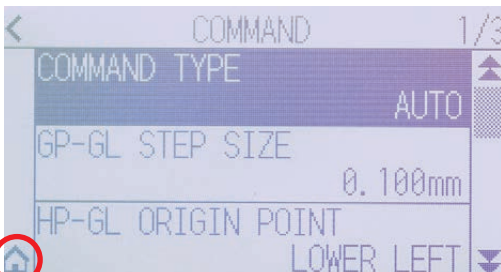

15. Press "HOME" at the bottom left.

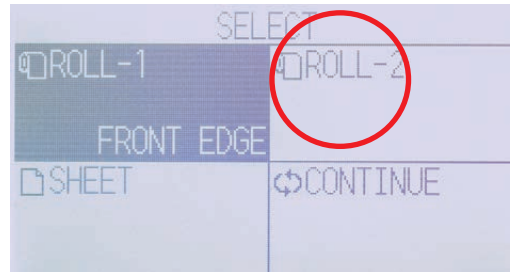

16. Restart the plotter, load any material, raise the lever on the back and press ROLL-2.

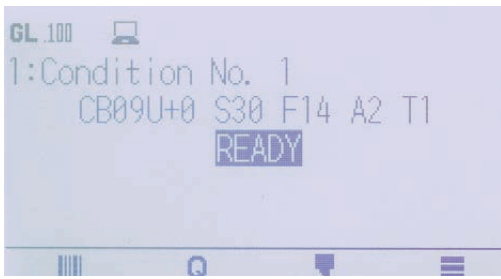

17. Wait until on the display appears “READY”.

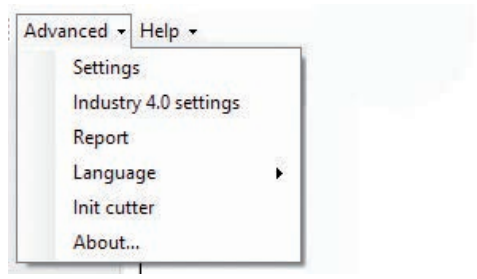

18. Open the Cutting manager, click on “Advanced” and then select “Init cutter”. Click “YES” to confirm

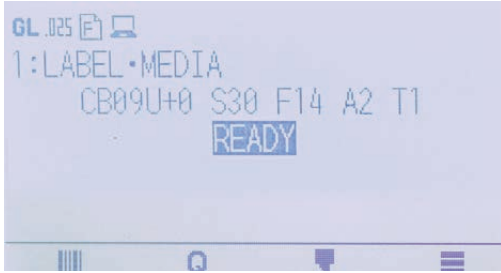

19. Wait until “Init cutter completed” will be shown in the status bar.  
Plotter display will show “LABEL MEDIA” as status.

## WHEN AND HOW TO REDUCE THE PLOTTER FEEDING SPEED

---

When cutting label longer than 250mm, is recommend to decrease the cutting speed. The cutting speed reduction depends on the job in process.

**The cutting speed can be set within the range of 50 to 600.**



## LAMINATION MODULE

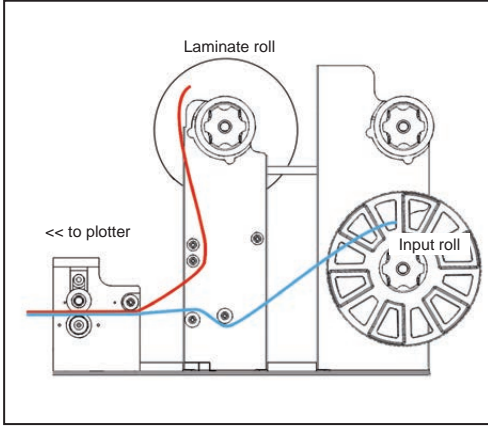

LAMINATION MODULE  
(without liner)

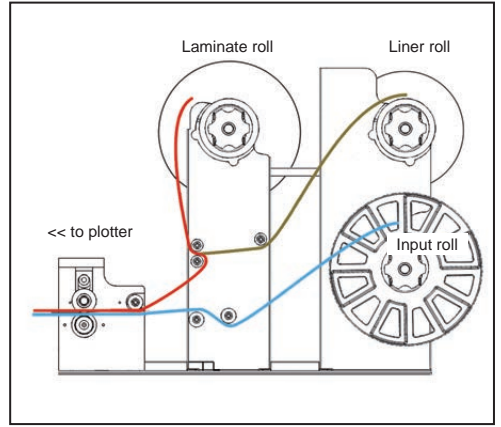

LAMINATION MODULE  
(with liner)

## MATRIX REMOVER & SLITTER MODULE

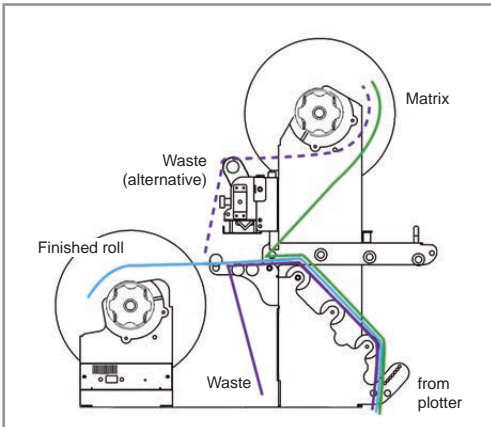

MATRIX REMOVER  
AND SLITTER MODULE



**CAUTION:**

Both cardboard cores loaded must be with the same external diameter.

## LAMINATION MODULE

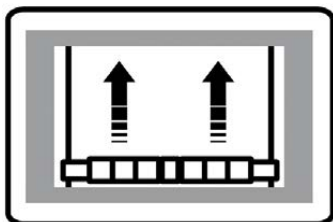

**SPEED  
INCREASE**

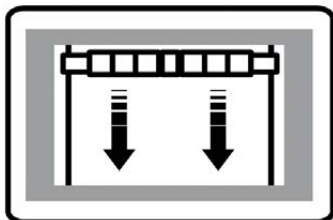

**SPEED  
DECREASE**

## MATRIX REMOVER & SLITTER MODULE

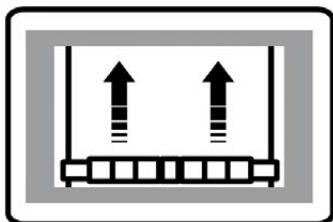

**SPEED  
DECREASE**

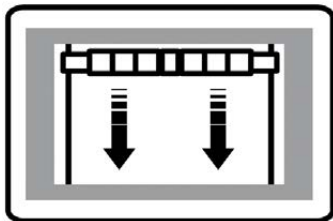

**SPEED  
INCREASE**

## HOW TO INSTALL PRESSING ROLLER

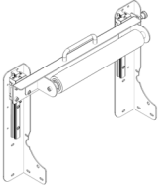

The pressing roller facilitates the matrix removal from the die-cut roll.

How to install the roller:

**1**

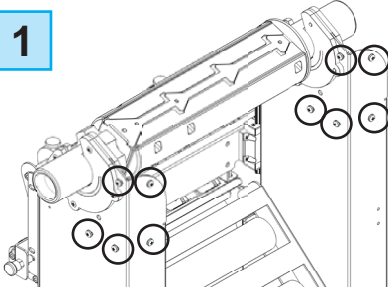

Unscrew the 10 screws on the matrix remover module.

**2**

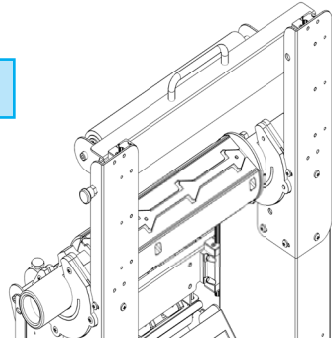

Position the matrix remover roller onto the matrix remover module and secure it properly with the 10 screws.

## HOW TO USED THE O-RING ON THE MATRIX ROLLER

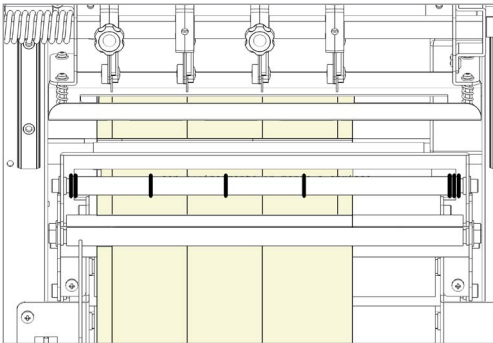

The o-rings of the matrix remover roller are used to facilitate the removal of your matrix from the labels.

Place one or more o-rings (depends on the width of the label) at the center of the die-cut label.

Then proceeds with the normal loading of the media. (pag. 16)

## NARROWER MEDIA ON THE SCR35 AND SCR35PL



In order to use narrower media (from 108 to 220mm wide) on the Scorpio SCR35 or SCR35PL, load the roll of labels exactly at the correspondence of the label onto the unwinder core holder.

Then load the empty cardboard core(s) in correspondence of the label onto the rewinder core holder.

## Cutter Plunger

The plotter cuts using a cutter blade mounted in a plunger. There are two different plungers to suit the diameter of the cutter blade to be mounted (the 0.9 mm cutter plunger is provided as a standard accessory). Be sure to mount the cutter blade in the corresponding cutter plunger.

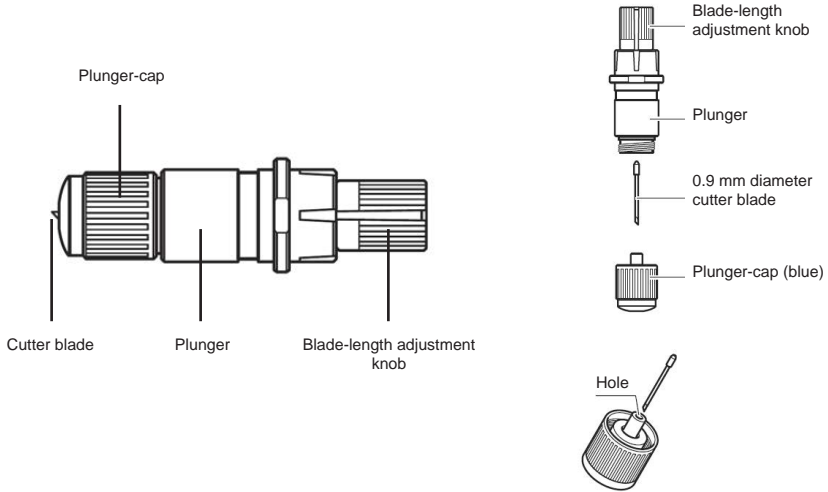

### **CAUTION:**

To avoid bodily injury, handle cutter blades with care.



**WARNING:** It may result in damaging the cutter blade or the cutting mat if the blade is extended too much. Make sure the blade length is set less than the thickness of the media.

Adjust the blade length by turning the blade-length adjustment knob. Turn the knob in direction “A” to extend the blade, or in direction “B” to retract the blade. When the knob is turned by one scale unit, the blade moves approximately 0.1 mm. One full turn of the knob moves the blade approximately 0.5 mm.

Cutter blade moves approximately 0.1 mm turning one scale unit

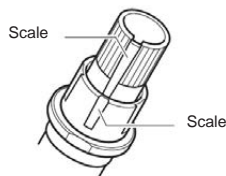
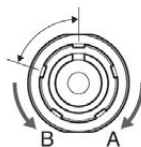

## **Mounting the tool**

1. Loosen the tool holder screw.

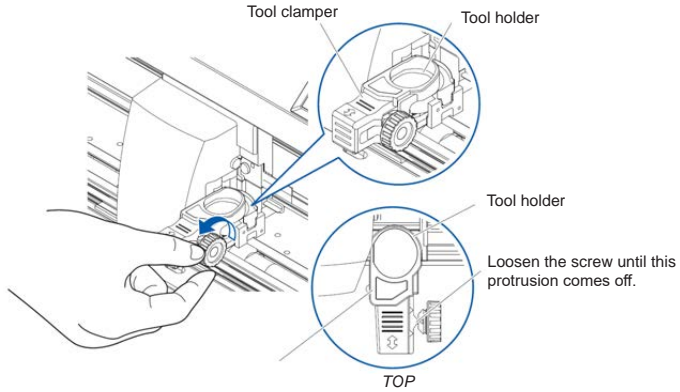

2. While pushing up the tool clamber, set the tool in the tool holder.

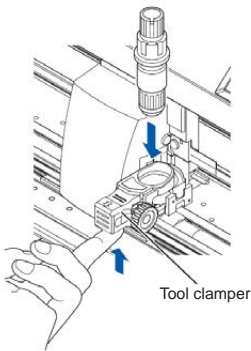

**When using with the cutting out**

**PERFORATION CUT**

Move using the triangle mark in the back as a guide.

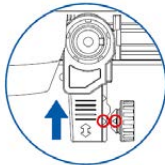

**When using with half cut and pen**

Move using the triangle mark in the forward side as a guide.

3. Make sure the tool is set straight into the tool holder, then tighten the tool holder screw.

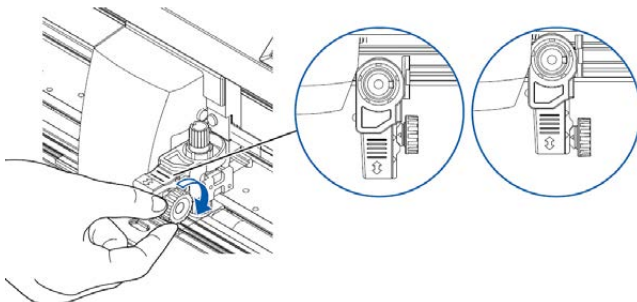

## **Removing the tool**

To remove the tool, loosen the screw until this protrusion mentioned in step 1 of “Attaching a tool” comes off and then remove the tool.

## HOW TO REPLACE THE KNIFE

See page 28 for the structure of the cutter plunger.

1. Turn the blade-length adjustment knob in the direction of the B arrow and pull the blade into the plunger.

Cutter blade moves approximately 0.1 mm turning one scale unit

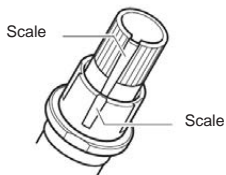
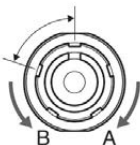

2. Turn the plunger cap in the counter-clockwise direction to remove it from the plunger.
3. Remove the blade from inside the plunger cap.
4. Remove a new blade from its pack. Insert the new blade into the hole provided in the plunger cap.
5. With the blade inserted into the plunger cap, screw on the plunger from above.
6. Fix the plunger cap by turning it clockwise.



**ATTENTION:** *In order to preserve the lifespan of the plotter knife and not to wear it out quickly, it is best to properly calibrate the knife exposure and cut force depending on the media thickness.*

## HOW TO REPLACE THE SLITTER BLADE

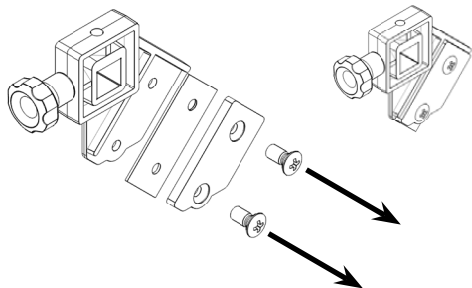

Loosen the two screws holding the blade in place.

Replace the blade.

Fix back the screw to holding the blade in place.

# HOW TO REPLACE THE CUTTING MAT



## CAUTION:

**Please turn off the power when replacing the cutting mat.  
Please move the tool carriage to "A" position allowing  
for ease of work.**

### 1. Remove the cutting mat.

- The cutting mat is attached to the cutting base (fig.2)
- Please remove only the cutting mat from the cutting mat base from the location shown by the arrow (A) (fig.1)

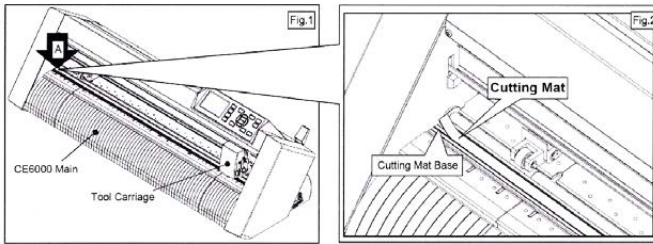

- After removing the cutting mat, please make sure that there is no adhesive tape or other adhesives left on the cutting base.
- Please clean the cutting mat base before installing the cutting mat.
- Installing the cutting mat with the remaining adhesive may affect cut quality.

### 2. Installing the cutting mat.

- Fit the cutting mat with the front cutting base grooves (fig.3) and attach it from the location shown by the arrow (A) (fig.1) while peeling off the release paper.

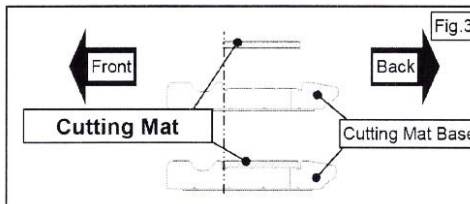

## HOW TO CREATE THE QR CODE

This feature allows system to load automatically the cut file related the job printed onto the media.

Simple steps to set properly the data matrix code.

- use any QR code generator.
- mandatory size is 10x10mm.
- printed once at the beginning of each job.
- positioned at least 5mm from the media edge (same site of black-mark).

### QR / DATA MATRIX SPECIFICATION

*F(diecut file name),D(distance between marks(mm))*

Example:

*FFILE\_A\_A,D220*

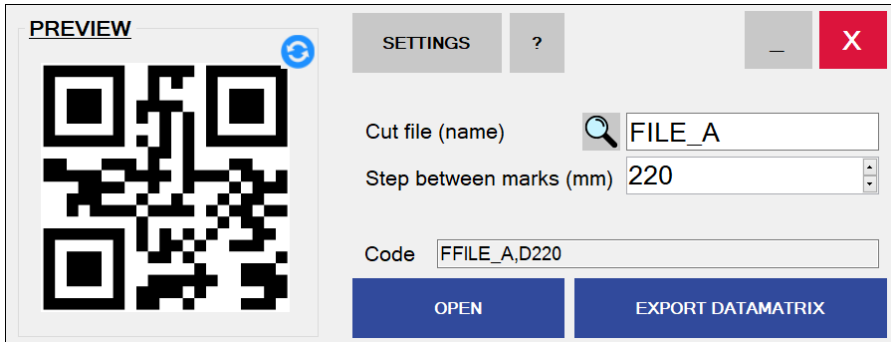

The screenshot shows a software interface for generating QR codes. On the left, a 'PREVIEW' window displays a QR code. To the right, there are several controls: a 'SETTINGS' button, a search icon, and three input fields. The first field is labeled 'Cut file (name)' and contains 'FILE\_A'. The second field is labeled 'Step between marks (mm)' and contains '220'. The third field is labeled 'Code' and contains 'FFILE\_A,D220'. Below these fields are two buttons: 'OPEN' and 'EXPORT DATAMATRIX'. The interface also features a 'QUESTION MARK' icon and a red 'X' button in the top right corner.

QR CODE GENERATOR

To create a QR / DATA MATRIX with the previous specifications, the quickest way is to use our **“Taurus Code Generator”** application (downloadable from our website)



### !!IMPORTANT!

*Make sure to write exactly the same cut file and laser parameters name including any space or symbol.*



## QR POSITION IN THE MEDIA

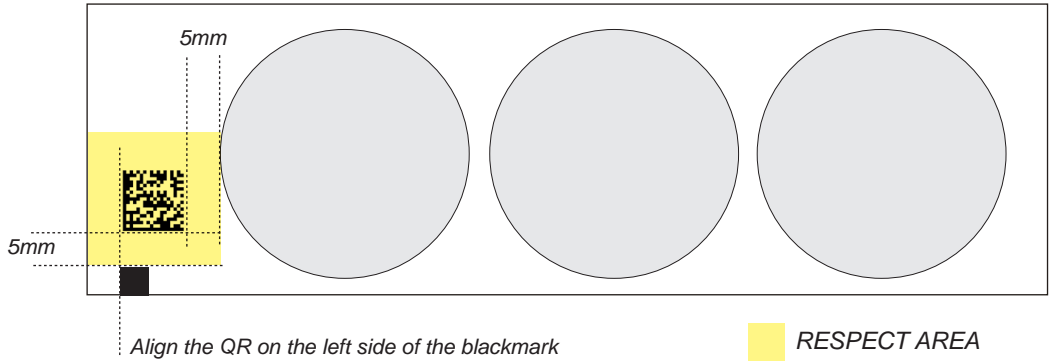

## HOW TO RUN THE QR MODE

The cutting manager allows you to work with QR codes, for cut different jobs on the same roll.

The camera will scan the code and load automatically the required parameters. You have only to make sure that the cut files are put inside the barcode folder.

To see its location, click on the top left the “Advanced” button in the main interface, then settings, then click “BARCODE FOLDER”.

*To start a job follow these steps:*

1. On the top left click on “Advanced” and go into “Settings”.
2. Flag “QR MODE” and click “Save”.



3. Move the mark and the QRcode inside the camera view with the forward and backward media buttons.

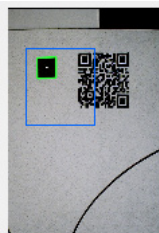

4. Set the cut force and speed desired.
5. Run a job with “Start” or “Cut Test”. The camera will read the QR code and load the cut file and parameters.

## IF YOU ARE EXPERIENCING THE FOLLOWING ISSUES WITH THE ANY OF OUR SCORPIO UNITS, PLEASE FOLLOW TROUBLESHOOTING STEPS BELOW

---

### **Yellow and Green LED's simultaneously on lamination control board** **(Applies to all Scorpio models)**

**Problem:** Yellow and Green LED's simultaneously on lamination control board. This will also create the following error:

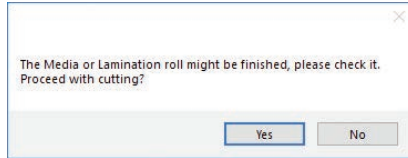

**Cause:** All Scorpio Digital Finishing Systems are equipped with two reflective sensors on the lamination module. One is the media sensor, located right after the first two guide rollers, and the other is the lamination sensor, mounted between the two black knobs on the rubber roller assembly. When both the yellow and green LED's on lamination control panel are on, it would indicate that either one or both of the sensors have picked up an error and the cause could be due to either the media or lamination roll has run out or the sensors may be out of sync and needs to be re-calibrated. The following steps below will show you how to tell when each sensor is in error mode and how to correct it or help you re-calibrate each sensor if needed.

### **Media not aligned properly**

**Problem:** If the media is not aligned properly after running a couple of jobs.

**Cause:** This problem occurs for a couple of reasons. The primary reason would be that the tension force on the on the rubber roller assembly, media core and the lamination core (If using lamination) are all out of sync and needs adjusting. Another reason could be that the media was wounded unevenly to begin with thus creating an uneven media roll. Make sure the distance between top to top black-marks is set correctly.

**Fix:** First check to see if you have a flat even media roll before you begin installation. An uneven media roll will cause the job to misalign itself. If that checks out ok, then you will need to adjust the tension force on the lamination module. To do this you must turn the two black knobs located at the top the rubber roller assembly to adjust the tension force until you receive satisfactory results. If needed, this may have to be done in conjunction with adjusting the clutch tension on both the lamination core (*If using lamination*) and the material core using the aluminum handles. Adjust the tension force at all three locations accordingly until you get the perfect setting and the media is properly aligned.

## Plotter error “E01017 Hardware X Position Alarm Power off then on”

**Problem:** The plotter displays an error “E01017 Hardware X Position Alarm Power off then on”.



E01017 HARDWARE  
X POSITION ALARM  
POWER OFF THEN ON

**Cause:** The plotter will give you this error after starting a job in *Scorpio CM* and the tensioner arm was not set-up to begin with or the tensioner arm was positioned too high after turning on the lamination module.

**(\*\*NOTE\*\* To set the tensioner arm properly, the arm must always be at a midpoint position or lower before turning on the lamination module).**

### **Fix:**

1. To set-up the tensioner arm, first turn off lamination module.  
**(\*\*NOTE\*\* The lamination module must be off for the next steps to work.)**
2. Use the arrow buttons at the top of the control panel to manually feed the media forward until the arm descends into the correct position (**\*\*Correct position for the tensioner arm will be midpoint or lower\*\***).
3. Once Tensioner is in the correct position, turn ON lamination module.  
**(If done successfully, the tensioner arm will automatically re-adjust itself thus activating the unwinder motor).**
4. Restart Cutting Manager software

## Plotter is not cutting or Plotter cutting all the way through the material

**Problem:** After starting a job, you notice that the plotter is not producing a clean cut through the media or the plotter is cutting all the way through the media.

**Cause:** This happens if cut force in or blade exposure may be set too low if it's not producing a clean cut or if it's cutting all the way through the media it could be set too high.

**Fix:** If the plotter is not producing a clean cut, this can be fixed by either; increasing the cut force in *Scorpio CM* while decreasing the blade exposure until the unit provides satisfactory results or you can also decrease the cut force and increase the blade exposure until it produces a perfect cut. Adjust both accordingly until the correct cut setting has been achieved.

If the plotter is cutting through the media, this can be fixed by decreasing both the cut force and blade exposure to factory settings and start by increasing the cut force until you get a clean cut. You may have to increase the blade exposure while decreasing the cut force there's a clean cut and the correct settings is has been achieved.

**(\*\*NOTE\*\*You can continue to increase the blade exposure if necessary, but remember that when you increase the blade exposure, do not simultaneously increase the cut force or you will cut through the cutting mat below the media. It is always best to increase one setting while decreasing the other or just increasing one setting only, normally the blade. Never increase both settings simultaneously)**

### **Plotter error “E01019 Hardware Y Position Alarm Power off then on”**



**Problem:** The plotter displays an error “E01019 Hardware Y Position Alarm Power off then on”.

**Cause:** This error occurs when the blade tray was moved from side to side by the user after loading the media onto the plotter and with the rear plotter lever in the up position.

**Fix:** To fix this error, you must first power off the plotter, turn the plotter back on, wait for the display on the plotter to load, then press the number “2” as instructed on the plotter to complete the set-up.

### **Plotter error “E05004 Hardware Realign Push Rollers Confirm”**

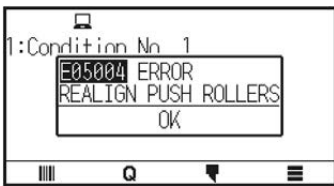

**Problem:** The plotter displays an error “E05004 Hardware Realign Push Rollers Confirm”

**Cause:** This error occurs when the pinch rollers are not aligned properly with the plotter’s grips.

**Fix:** Before feeding the material through the plotter (While the rear lever is in the down position) be sure that the pinch rollers are aligned properly with the plotter’s grips.

### **Cutting Manager error “Black-mark not found”**

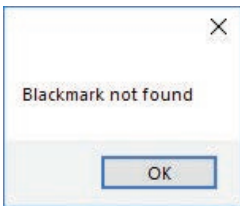

**Problem:** After starting a job in *Scorpio CM*, you get an error “Black-mark not found”.

**Cause:** This problem occurs when after you start the job and the software can’t detect the black-mark on the media. The reason for this could be the following; the media is missing a marker to begin with; the media is not aligned with

the arrows points labeled on the front and back of the plotter; the plotter’s camera is not positioned correctly; and the plotter’s camera is picking up too much exposure from the sunlight or another light source.

**Fix:** To fix this, before you start any job in *Scorpio CM* be sure to always do the following; check and make sure the media has a black-mark printed on it to begin with; manually aligned the media with the arrows points labeled on the front and back of the plotter (*This is done with the plotter’s rear handle in the down position*); make sure to position the plotter’s camera over the blackmark in order to centered marker as much as possible on the software camera preview.

**The Media or Lamination roll might be finished, please check it. Proceed with cutting?**

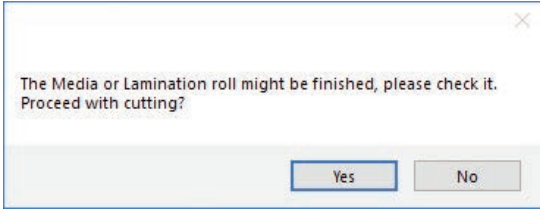

**Problem:** Yellow and Green light simultaneously on lamination control board.

**Cause:** When both the yellow and green LEDs on lamination control panel are on, it would indicate that either the media or lamination sensor have picked up and error or the sensors may be out of sync and needs to be calibrated.

**Fix:** To fix this, please refer to the “Yellow and Green LED’s simultaneously on lamination control board” guide above to resolve.

**Error: load the media**

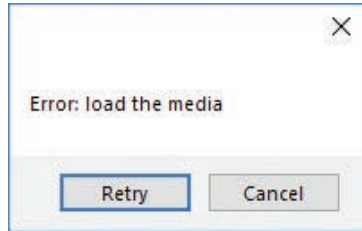

**Cause:** You launched the Cutting Manager while the plotter’s lever was down.

**Fix:** Rise the lever on the plotter, than press the button 2 on control panel and wait until the display will show “READY” as status. Then press retry on the popup window.

**Dongle not found**

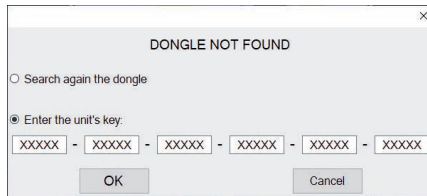

**Cause:** This occurs after opening the software while the dongle (the red key) was not plugged into the internal hub. This can also take place when the USB cable from the unit was not plugged to the pc or when you’re first installing the software.

**Fix:** Plug the dongle to the hub, or the unit USB to the pc and click retry. If this does not fix the issue, please contact your dealer to get a new activation key and go to the section titled “SOFTWARE ACTIVATION” at page 9 for further instructions.

### Can't load sensors

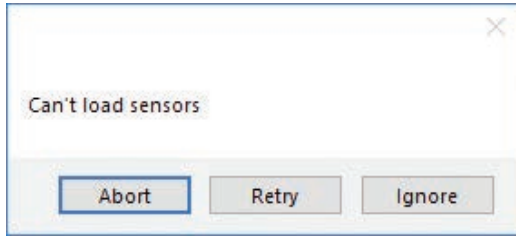

**Cause:** Media/Lamination sensors might be not plugged in correctly or turned off.

**Fix:** Check if sensors are powered up and plugged correctly into the black sensor box. Then Retry. If you do not want to keep activated the sensors, click Ignore.

### Error: plotter not found

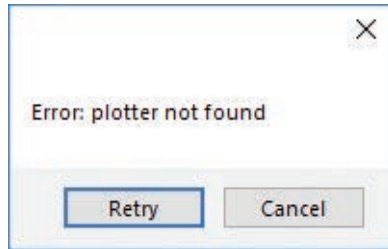

**Cause:** The plotter might be switched off or not properly connected.

**Fix:** Make sure the plotter is turned on and properly connected.

**In case it is turned off, please turn the plotter on and then press the button 2 on control panel and wait until the display will show "READY" as status. Then press retry on the popup window.**

### Last job not found

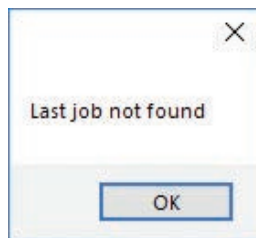

**Cause:** You will get this error when you try to open the last job when you run Cutting Manager for the first time after the installation.

**Fix:** Choose your file through "Open PDF".

**Please forward the media to the next black-mark**

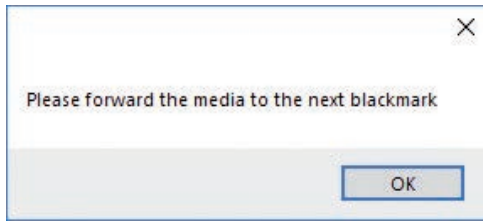

**Cause:** The starting Y position of the cut is a negative value (you can see coordinates on plotter's display when you move the media with arrows). **Keep in mind also the offset influences the starting position of the cut. So, if you start the cut at Y coordinates 0, while you have an offset Y value of -10, you will still get this error.** This error might happens when the media has been just loaded.

**Fix:** Move to the next black-mark. If it is not enough, forward until you have reached Y coordinate value major than 0.

**Please forward the media to reach a positive Y value shown on the plotter's display**

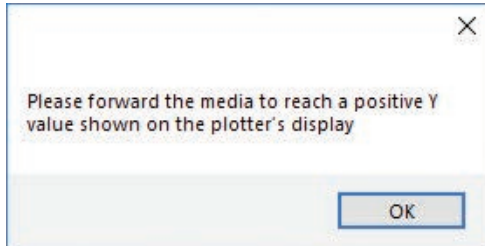

**Cause:** The starting Y position of the cut is a negative value (you can see coordinates on plotter's display when you move the media with arrows). This error might happens when the media has been just loaded.

**Fix:** Move forward until you have reached positive Y coordinates.

## **Error after opening a .pdf file**

- Cause:**
- The antivirus doesn't allow the software to open the file
  - The file is loaded from a server web or a remote disk. This may create issues sometimes
  - The file is not properly built

- Fix:**
- Add the cutting manager to your antivirus's whitelist
  - Move your file to your computer
  - The cutting file must contain only:
    - The contours lines
    - The Black-Mark, in case of Black-Mark mode cutting

## **Processing the cut job had issues, or error after opening a .pdf file**

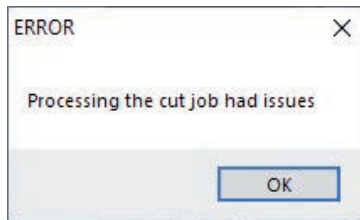

Make sure that:

- 1- The cut file contains **JUST VECTORIAL LINES AND NOT ANY FILLED FIGURE**, and has been built properly.
- 2- The cut file is opened from a pc folder, and not any usb or external network folder.
- 3- Add the cutting manager to your antivirus's whitelist.
- 4- Use just standard occidental letters or numbers for the file name.

## **E02001 GPGI Error 1 command error!**



Make sure that:

- 1- The cut file contains **JUST VECTORIAL LINES AND NOT ANY FILLED FIGURE**, and has been built properly.
- 2- The cut file is opened from a pc folder, and not any usb or external network folder

***If this doesn't solve, restore and init the plotter (pag.22)***